

VARUN IMPEX
Solutions for Furniture Industry

CONNECTORS &
SHELF-SUPPORTS

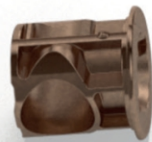

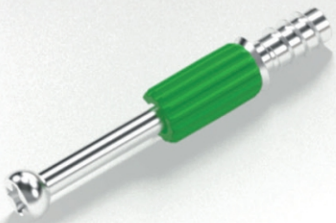

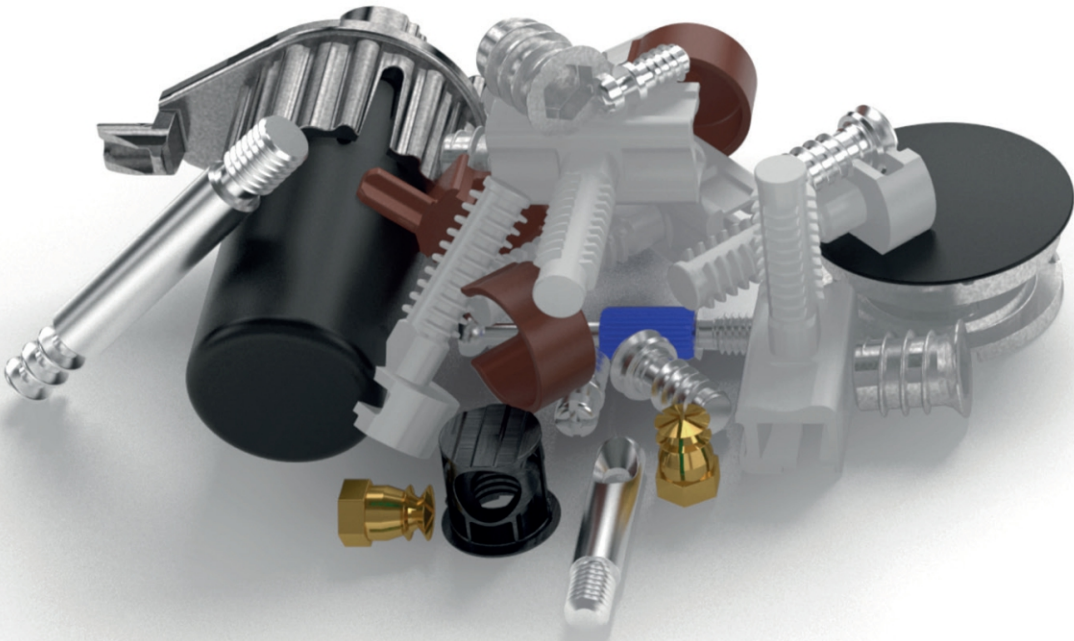
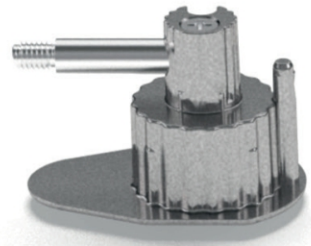
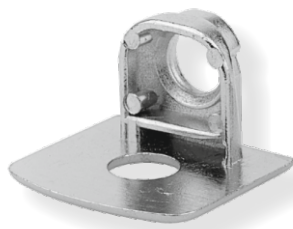



CONNECTING FITTINGS FOR KITCHENS & WARDROBES

Connector Fitting (Dowel) for 18mm

This fitting have cylindrically shaped metal nut (i.e., a metal dowel) that is used to join two pieces of wood.

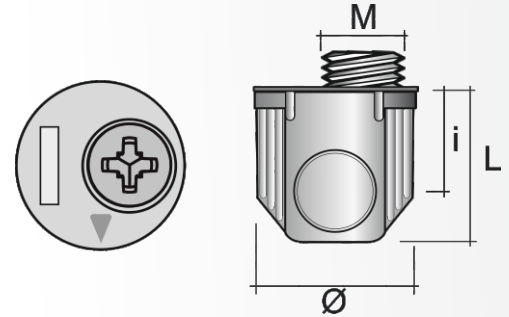
Article	Ø	L	M	i			
BO93	15	14,2	M8	9	18	1,000	10,3



Article	Ø	F	M	L		
TF80	7	21	M6	8,5	2,000	12,5

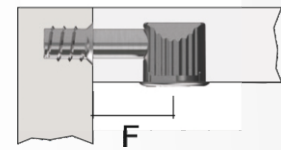
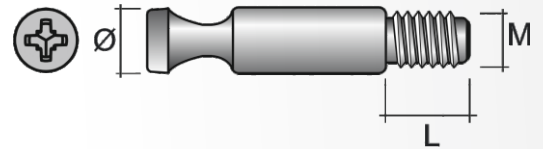

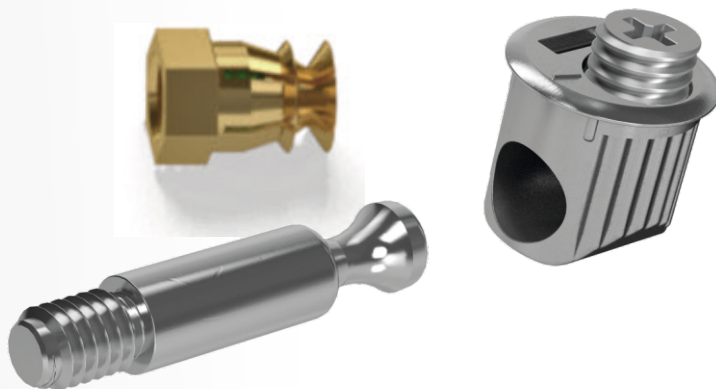
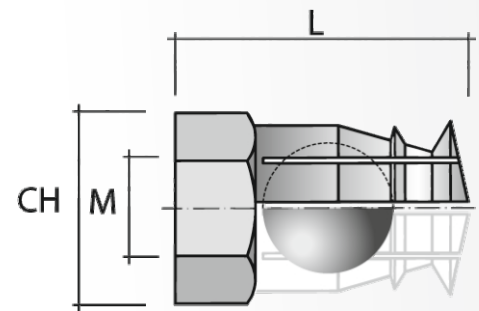

Article	CH	L	M		
BU12	8	12	M6	5,000	11,1





CONNECTING FITTINGS FOR KITCHENS & WARDROBES

Shelf Support (Flips)

This shelf support design allows easy, fast, and safe installation of shelves. The unique concept allows downward on to the side dowels until it is safely locked in position by a clicking sound.

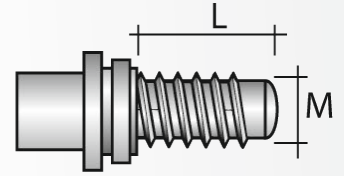
Article	M	L		
PV23	6EURO	11	2,500	10,3



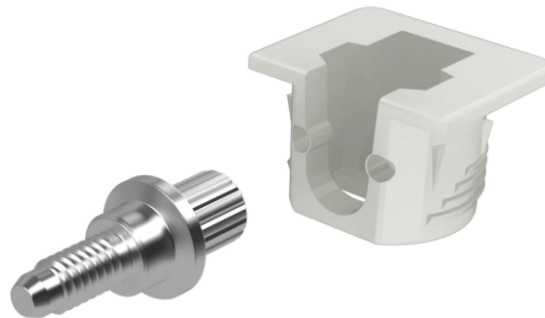
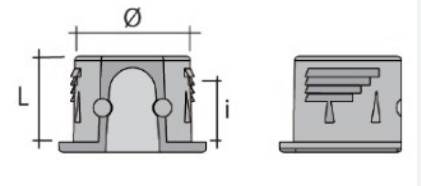

Article	∅	L	I		
SI21	15	13,7	9,0	5,000	8,1





Connectors for Cabinet

Screws and Sleeves are Nickel plated for good aesthetics. Used to join boards of various thickness ranging from 32- 48mm

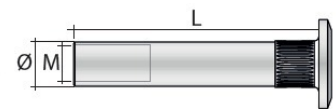
Article	∅	L	M		
VF57	5	27	M4	2,000	6,8





Article	L	M		
VC57	15	M4	5,000	15,4



CONNECTING FITTINGS FOR KITCHENS & WARDROBES

Adjustable Levellers 60mm

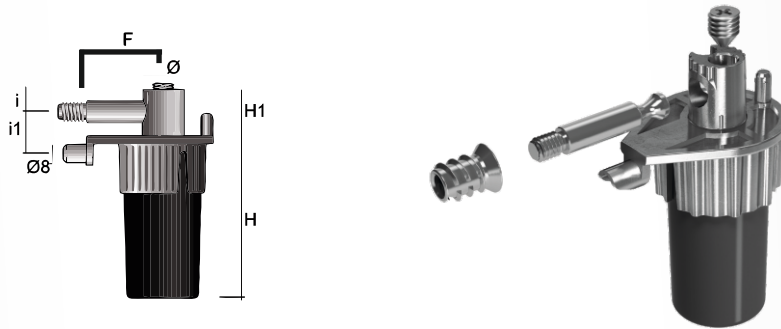

This Adjuster leveller used in modular office furniture, Workstation and several other furniture items manufacturing.

Article	F	i	i1	Ø	H1	H		
PI91	21	9	16	15	18	min 59 max 74	100	9,5





Shelf Support (Block)

Is the new concept in wood shelf supports, to be slotted into the panel by making face borings. It allows to join together any side and shelf, including bottom and top, without using any further connecting fitting.

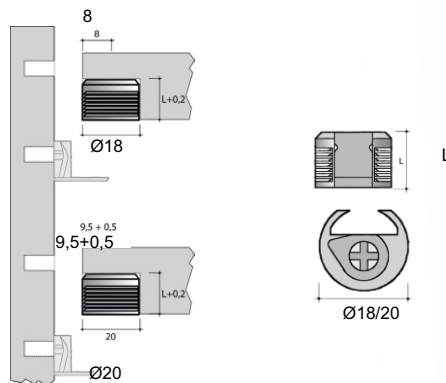
Article	L			
SO011	14,2	18/19	5,000	19,1



Article	l			
SO032	9	18/19	1,000	5,2

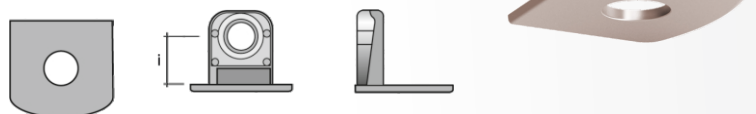

VARUN IMPEX

Address:

Gala No.1 & 4, Plot No.21, Papdy
Industrial Estate, Umela Phata,
Vasai Road (West), Palghar - 401207.
Mob.: +91 9167883194
Email: varunimpexkba@gmail.com
Website: www.varunimpex.in